







OSLO 3038-19

PROJECT PROJET
SPEC TYPE
NOTES



FAMILY FAMILLE



4238-19 3038-19 (WALL) 4238-19

OPTIONS



REF-WHE NBF-WHE SGF-WHE CHF-WHE

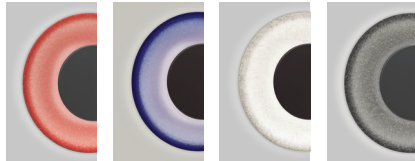

REF-ANTE NBF-ANTE SGF-ANTE CHF-ANTE

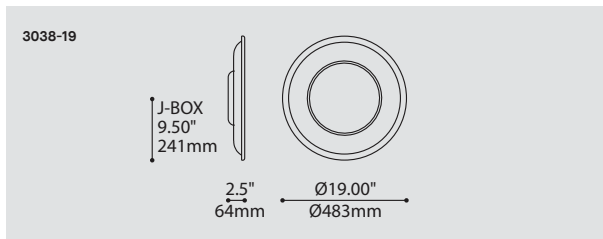

ORDERING SPECIFICATION	SPÉCIFICATION DE COMMANDE	CODE
MODEL MODÈLE		3038-19
3038-19	OSLO	
LIGHT SOURCE SOURCE LUMINEUSE		LED
(WATTAGE, LAMP TYPE, OTHER INFO)		
LED	REGULAR OUTPUT	
COLOR TEMPERATURE TEMPÉRATURE DE COULEUR		
27	2700K	
30	3000K	
35	3500K	
40*	4000K	
	* LONGER LEAD TIME MAY APPLY. PLEASE CONTACT YOUR EUREKA REPRESENTATIVE	
COLOR RENDERING INDEX (CRI) INDICE DE RENDU DE COULEUR (IRC)		90
90	90+ CRI	
VOLTAGE VOLTAGE		
120V	120 VOLT	
277V	277 VOLT	
DIMMING OPTION OPTION DE GRADATION		
DV	0-10V DIMMING (120-277V)	
DP	PHASE DIMMING (120V ONLY)	
	LED DIMMING DRIVER IS STANDARD IN THIS PRODUCT. PLEASE SPECIFY YOUR DIMMING TYPE.	
DECORATIVE PLATE FINISH FINI PLAQUE DÉCORATIVE		
WHE	WHITE FINE TEXTURE	
ANTE	ANTHRACITE FINE TEXTURE	
SHADE FINISH FINI ABAT-JOUR		
CHF	CHARCOAL FELT	
REF	RED FELT	
SGF	SILVER GRAY FELT	
NBF	NAVY BLUE FELT	

PRODUCT CHARACTERISTICS CARACTÉRISTIQUES DU PRODUIT



- DESIGN:** Now available in two formats, this surface sconce features front and back light giving a nicely toned atmosphere to interior spaces. Made out of formed recycled acoustical PET felt, the shape reminds the effects of rippling water.
- INSTALLATION:** Featuring no visible fasteners, the Oslo installs on a standard junction box with two screws. The front cover is spun in place on the housing.
- LIGHT SOURCE:** Designed with front as well as rear illumination, the Oslo features a LED light source and standard 0-10V or phase dimming.
- SHADE:** Using compression molding to create this beautiful volume, Oslo is available in 4 colours: red, blue, charcoal and silver gray. Made from recycled and recyclable polyester (PET) fibers with characteristics like low VOCs, no formaldehyde, non-irritable and odourless.
- CERTIFIED:** c-CSA-us
- CONCEPTION:** Maintenant offert en deux formats, ce luminaire chaleureux et délicat offre une illumination diffuse et d'ambiance. Fait de feutre acoustique en fibre de PET recyclé, sa forme rappelle l'ondulation de l'eau.
- INSTALLATION:** Avec deux vis non visibles, l'Oslo s'installe simplement sur une boîte de jonction standard. L'abat-jour est ensuite fixé sur l'assemblage en le tournant.
- SOURCE LUMINEUSE:** Offert avec une source DEL à gradation standard 0-10V ou phase qui illumine dans deux directions.
- ABAT-JOUR:** Fabriqué par moulage en compression afin de créer son volume tout en courbes, Oslo est offert en 4 couleurs: rouge, bleu, gris pâle et charbon. Composé de fibres de polyéthylène (PET) recyclées et recyclables avec bas COV, sans formaldéhyde, non irritante et inodore.
- CERTIFIÉ:** c-CSA-us

OSLO 3038-29

PROJECT PROJET
SPEC TYPE
NOTES

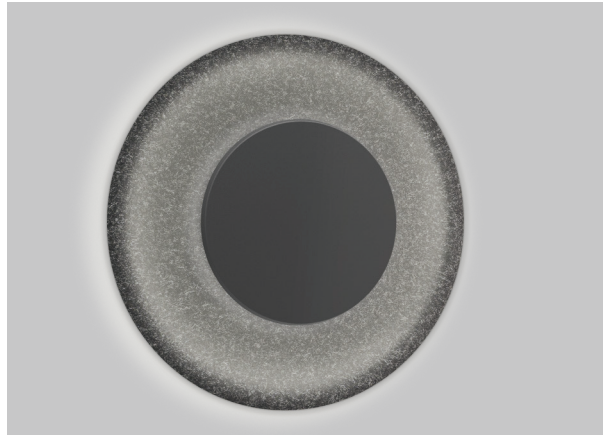

FAMILY FAMILLE



3038-29 (CEILING)

4238-29

OPTIONS

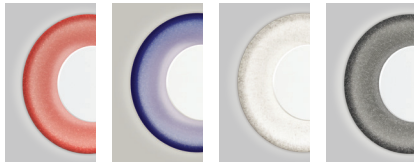

REF-WHE NBF-WHE SGF-WHE CHF-WHE

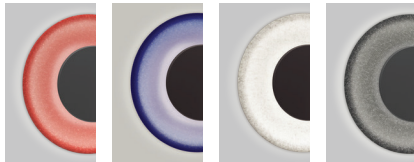

REF-ANTE NBF-ANTE SGF-ANTE CHF-ANTE

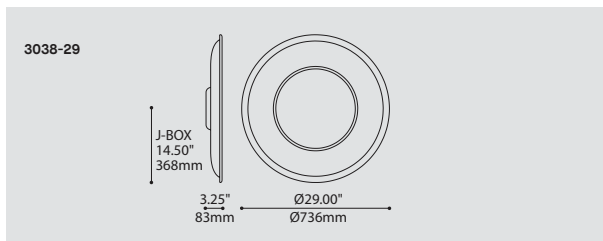

ORDERING SPECIFICATION SPÉCIFICATION DE COMMANDE		CODE
MODEL MODÈLE	3038-29 OSLO	3038-29
LIGHT SOURCE SOURCE LUMINEUSE	LED	LED
(WATTAGE, LAMP TYPE, OTHER INFO)		
LED	REGULAR OUTPUT	
COLOR TEMPERATURE TEMPÉRATURE DE COULEUR		
27	2700K	
30	3000K	
35	3500K	
40*	4000K	
* LONGER LEAD TIME MAY APPLY, PLEASE CONTACT YOUR EUREKA REPRESENTATIVE		
COLOR RENDERING INDEX (CRI) INDICE DE RENDU DE COULEUR (IRC)		90
90	90+ CRI	
VOLTAGE VOLTAGE		
120V	120 VOLT	
277V	277 VOLT	
DIMMING OPTION OPTION DE GRADATION		
DV	0-10V DIMMING (120-277V)	
DP	PHASE DIMMING (120V ONLY)	
LED DIMMING DRIVER IS STANDARD IN THIS PRODUCT. PLEASE SPECIFY YOUR DIMMING TYPE.		
DECORATIVE PLATE FINISH FINI PLAQUE DÉCORATIVE		
WHE	WHITE FINE TEXTURE	
ANTE	ANTHRACITE FINE TEXTURE	
SHADE FINISH FINI ABAT-JOUR		
CHF	CHARCOAL FELT	
REF	RED FELT	
SGF	SILVER GRAY FELT	
NBF	NAVY BLUE FELT	

PRODUCT CHARACTERISTICS CARACTÉRISTIQUES DU PRODUIT



- DESIGN:** Now available in two formats, this surface sconce features front and back light giving a nicely toned atmosphere to interior spaces. Made out of formed recycled acoustical PET felt, the shape reminds the effects of rippling water.
- INSTALLATION:** Featuring no visible fasteners, the Oslo installs on a standard junction box with two screws. The front cover is spun in place on the housing.
- LIGHT SOURCE:** Designed with front as well as rear illumination, the Oslo features a LED light source and standard 0-10V or phase dimming.
- SHADE:** Using compression molding to create this beautiful volume, Oslo is available in 4 colours: red, blue, charcoal and silver gray. Made from recycled and recyclable polyester (PET) fibers with characteristics like low VOCs, no formaldehyde, non-irritable and odourless.
- CERTIFIED:** c-CSA-us
- CONCEPTION:** Maintenant offert en deux formats, ce luminaire chaleureux et délicat offre une illumination diffuse et d'ambiance. Fait de feutre acoustique en fibre de PET recyclé, sa forme rappelle l'ondulation de l'eau.
- INSTALLATION:** Avec deux vis non visibles, l'Oslo s'installe simplement sur une boîte de jonction standard. L'abat-jour est ensuite fixé sur l'assemblage en le tournant.
- SOURCE LUMINEUSE:** Offert avec une source DEL à gradation standard 0-10V ou phase qui illumine dans deux directions.
- ABAT-JOUR:** Fabriqué par moulage en compression afin de créer son volume tout en courbes, Oslo est offert en 4 couleurs: rouge, bleu, gris pâle et charbon. Composé de fibres de polyéthylène (PET) recyclées et recyclables avec bas COV, sans formaldéhyde, non irritante et inodore.
- CERTIFIÉ:** c-CSA-us

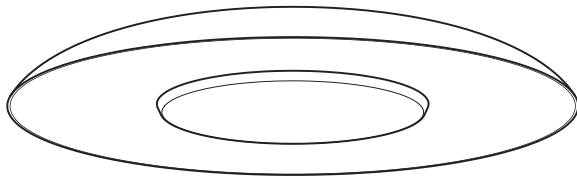

INDIRECT AND AMBIENT LIGHT

Design for a indirect lighting with an ambient outer glow.
Empress is suited for many installation context.

MOUNTING SYSTEM
For an easier and simpler installation on the wall and ceiling surface.

DEEP JUNCTION BOX
3035-22 installs to deep junction box (3983)

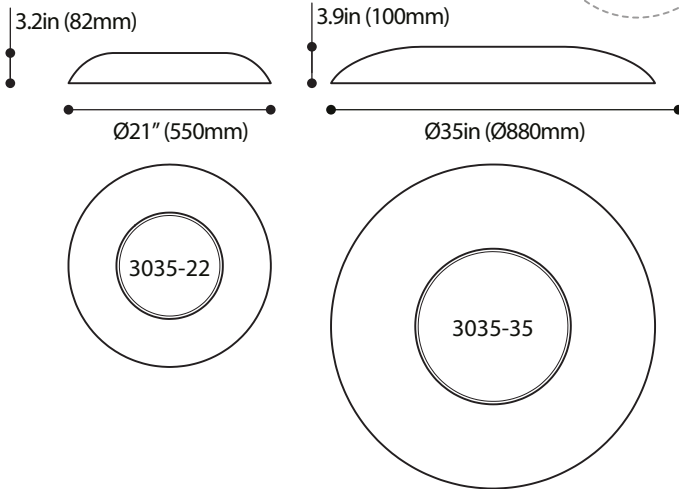
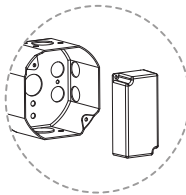

HIGH DIFFUSION
Custom made thermoformed and frosted white PMMA reflector for a soft and even light.

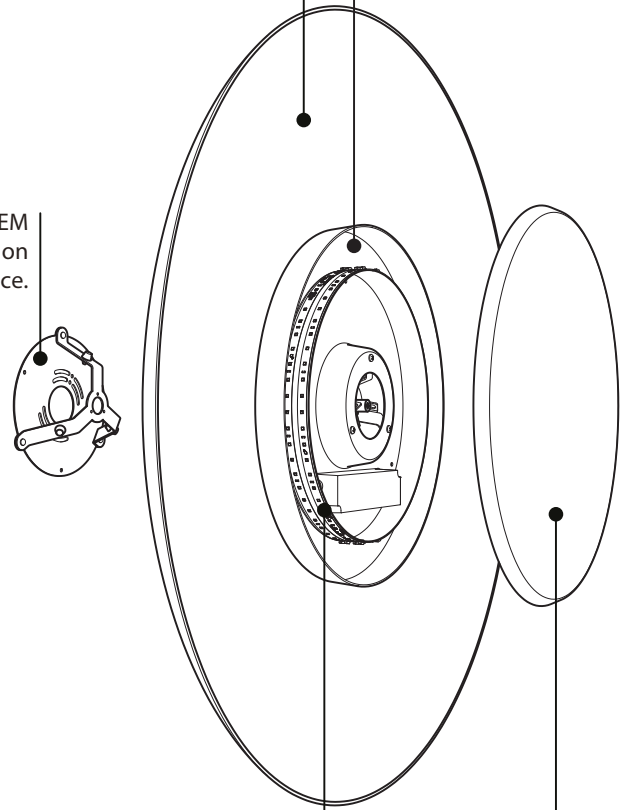

LED MODULES
Custom made high performance LED ring for a total of 22W or 30W.

FRONT PLATE
Die-spun steel dish, available in white architectural grade fine textured finishes.

PRODUCT SPECIFICATION	3035-22	3035-35
-----------------------	---------	---------

PERFORMANCE

SYSTEM WATTAGE	22.5 W	32.9 W
DELIVERED LUMENS (4000K)	1133,4 LM	1493,4 LM
EFFICACY	57 LM/W	52 LM/W

OTHER INFORMATION

LUMINAIRE'S WEIGHT	2,8 KG / 6,2 LBS	6,5 KG / 14,3 LBS
L70 (LUMEN MAINTENANCE)	60 000 HRS	60 000 HRS
MAX. LUMINANCE 45°-90° OF NADIR	958 CD/M ²	642 CD/M ²
LIGHT QUALITY	R9 > 50	R9 > 50

EFFICACY MULTIPLIERS

CRI	CCT	FACTOR
90+	4000K	1.00
90+	3500K	0.96
90+	3000K	0.92
90+	2700K	0.87

LIGHT DISTRIBUTION

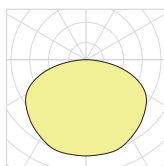

3035-XX



Visit our website for warranty terms and conditions.



OSLO 3038-19

PROJECT PROJET
SPEC TYPE
NOTES



FAMILY FAMILLE



4238-19 3038-29 (WALL) 4238-29

OPTIONS

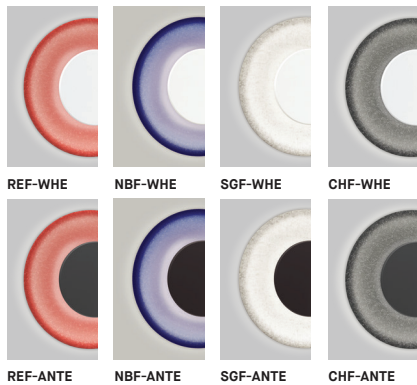

REF-ANTE NBF-ANTE SGF-ANTE CHF-ANTE

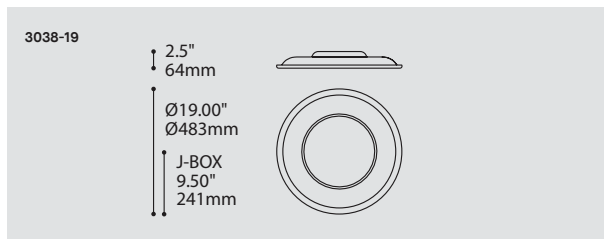

ORDERING SPECIFICATION SPÉCIFICATION DE COMMANDE		CODE
MODEL MODÈLE	3038-19 OSLO	3038-19
LIGHT SOURCE SOURCE LUMINEUSE	LED	LED
<small>(WATTAGE, LAMP TYPE, OTHER INFO)</small>		
LED	REGULAR OUTPUT	
COLOR TEMPERATURE TEMPÉRATURE DE COULEUR		
27	2700K	
30	3000K	
35	3500K	
40*	4000K	
<small>* LONGER LEAD TIME MAY APPLY, PLEASE CONTACT YOUR EUREKA REPRESENTATIVE</small>		
COLOR RENDERING INDEX (CRI) INDICE DE RENDU DE COULEUR (IRC)		90
90	90+ CRI	
VOLTAGE VOLTAGE		
120V	120 VOLT	
277V	277 VOLT	
DIMMING OPTION OPTION DE GRADATION		
DV	0-10V DIMMING (120-277V)	
DP	PHASE DIMMING (120V ONLY)	
<small>LED DIMMING DRIVER IS STANDARD IN THIS PRODUCT. PLEASE SPECIFY YOUR DIMMING TYPE.</small>		
DECORATIVE PLATE FINISH FINI PLAQUE DÉCORATIVE		
WHE	WHITE FINE TEXTURE	
ANTE	ANTHRACITE FINE TEXTURE	
SHADE FINISH FINI ABAT-JOUR		
CHF	CHARCOAL FELT	
REF	RED FELT	
SGF	SILVER GRAY FELT	
NBF	NAVY BLUE FELT	

PRODUCT CHARACTERISTICS CARACTÉRISTIQUES DU PRODUIT



- DESIGN:** Now available in two formats, this surface sconce features front and back light giving a nicely toned atmosphere to interior spaces. Made out of formed recycled acoustical PET felt, the shape reminds the effects of rippling water.
- INSTALLATION:** Featuring no visible fasteners, the Oslo installs on a standard junction box with two screws. The front cover is spun in place on the housing.
- LIGHT SOURCE:** Designed with front as well as rear illumination, the Oslo features a LED light source and standard 0-10V or phase dimming.
- SHADE:** Using compression molding to create this beautiful volume, Oslo is available in 4 colours: red, blue, charcoal and silver gray. Made from recycled and recyclable polyester (PET) fibers with characteristics like low VOCs, no formaldehyde, non-irritable and odourless.
- CERTIFIED:** c-CSA-us
- CONCEPTION:** Maintenant offert en deux formats, ce luminaire chaleureux et délicat offre une illumination diffuse et d'ambiance. Fait de feutre acoustique en fibre de PET recyclé, sa forme rappelle l'ondulation de l'eau.
- INSTALLATION:** Avec deux vis non visibles, l'Oslo s'installe simplement sur une boîte de jonction standard. L'abat-jour est ensuite fixé sur l'assemblage en le tournant.
- SOURCE LUMINEUSE:** Offert avec une source DEL à gradation standard 0-10V ou phase qui illumine dans deux directions.
- ABAT-JOUR:** Fabriqué par moulage en compression afin de créer son volume tout en courbes, Oslo est offert en 4 couleurs: rouge, bleu, gris pâle et charbon. Composé de fibres de polyéthylène (PET) recyclées et recyclables avec bas COV, sans formaldéhyde, non irritante et inodore.
- CERTIFIÉ:** c-CSA-us

OSLO 3038-29

PROJECT PROJET
SPEC TYPE
NOTES

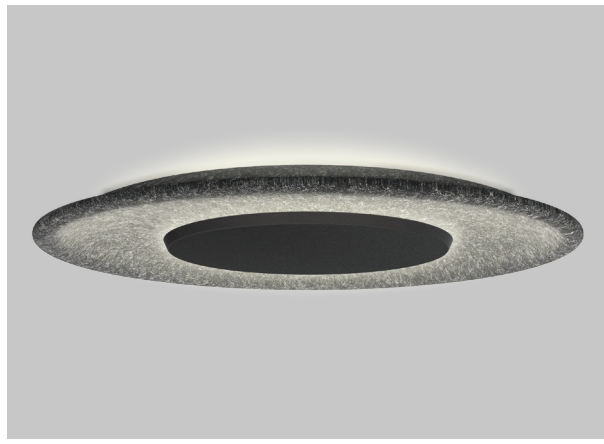

FAMILY FAMILLE

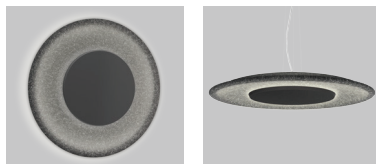

3038-19 (WALL) 4238-29

OPTIONS

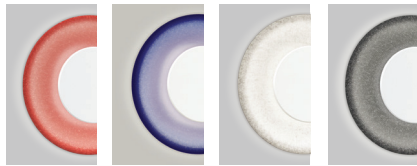

REF-WHE NBF-WHE SGF-WHE CHF-WHE

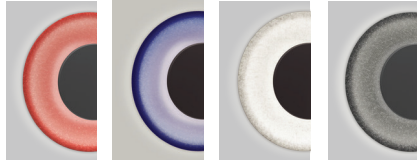

REF-ANTE NBF-ANTE SGF-ANTE CHF-ANTE

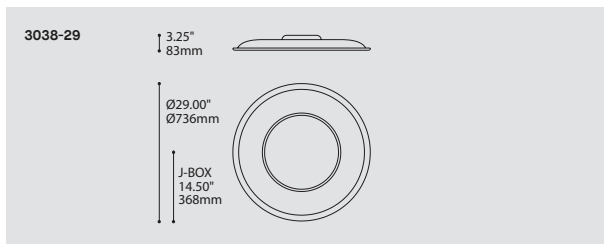

ORDERING SPECIFICATION SPÉCIFICATION DE COMMANDE		CODE
MODEL MODÈLE	3038-29 OSLO	3038-29
LIGHT SOURCE SOURCE LUMINEUSE	LED	LED
<small>(WATTAGE, LAMP TYPE, OTHER INFO)</small>		
LED	REGULAR OUTPUT	
COLOR TEMPERATURE TEMPÉRATURE DE COULEUR		
27	2700K	
30	3000K	
35	3500K	
40*	4000K	
<small>*LONGER LEAD TIME MAY APPLY. PLEASE CONTACT YOUR EUREKA REPRESENTATIVE</small>		
COLOR RENDERING INDEX (CRI) INDICE DE RENDU DE COULEUR (IRC)	90	90
90	90+ CRI	
VOLTAGE VOLTAGE		
120V	120 VOLT	
277V	277 VOLT	
DIMMING OPTION OPTION DE GRADATION		
DV	0-10V DIMMING (120-277V)	
DP	PHASE DIMMING (120V ONLY)	
<small>LED DIMMING DRIVER IS STANDARD IN THIS PRODUCT. PLEASE SPECIFY YOUR DIMMING TYPE.</small>		
DECORATIVE PLATE FINISH FINI PLAQUE DÉCORATIVE		
WHE	WHITE FINE TEXTURE	
ANTE	ANTHRACITE FINE TEXTURE	
SHADE FINISH FINI ABAT-JOUR		
CHF	CHARCOAL FELT	
REF	RED FELT	
SGF	SILVER GRAY FELT	
NBF	NAVY BLUE FELT	

PRODUCT CHARACTERISTICS CARACTÉRISTIQUES DU PRODUIT



DESIGN: Now available in two formats, this surface sconce features front and back light giving a nicely toned atmosphere to interior spaces. Made out of formed recycled acoustical PET felt, the shape reminds the effects of rippling water.

INSTALLATION: Featuring no visible fasteners, the Oslo installs on a standard junction box with two screws. The front cover is spun in place on the housing.

LIGHT SOURCE: Designed with front as well as rear illumination, the Oslo features a LED light source and standard 0-10V or phase dimming.

SHADE: Using compression molding to create this beautiful volume, Oslo is available in 4 colours: red, blue, charcoal and silver gray. Made from recycled and recyclable polyester (PET) fibers with characteristics like low VOCs, no formaldehyde, non-irritable and odourless.

CERTIFIED: c-CSA-us

CONCEPTION: Maintenant offert en deux formats, ce luminaire chaleureux et délicat offre une illumination diffuse et d'ambiance. Fait de feutre acoustique en fibre de PET recyclé, sa forme rappelle l'ondulation de l'eau.

INSTALLATION: Avec deux vis non visibles, l'Oslo s'installe simplement sur une boîte de jonction standard. L'abat-jour est ensuite fixé sur l'assemblage en le tournant.

SOURCE LUMINEUSE: Offert avec une source DEL à gradation standard 0-10V ou phase qui illumine dans deux directions.

ABAT-JOUR: Fabriqué par moulage en compression afin de créer son volume tout en courbes, Oslo est offert en 4 couleurs: rouge, bleu, gris pâle et charbon. Composé de fibres de polyéthylène (PET) recyclées et recyclables avec bas COV, sans formaldéhyde, non irritabile et inodore.

CERTIFIÉ: c-CSA-us





Tone down your space

Oslo have a custom molded reflector made out of acoustic PET felt to control noise in your space.

OSLO 4238-19

PROJECT PROJET
SPEC TYPE
NOTES



FAMILY FAMILLE



3038-19 (WALL)

4238-29

3038-29 (WALL)

OPTIONS



REF-WHE

NBF-WHE

SGF-WHE

CHF-WHE

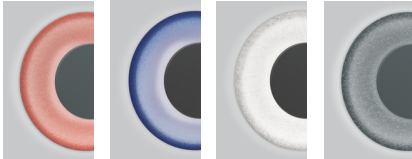

REF-ANTE

NBF-ANTE

SGF-ANTE

CHF-ANTE

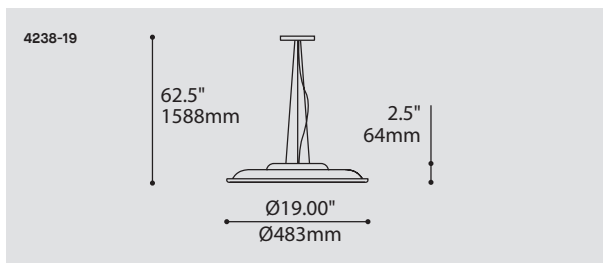

ORDERING SPECIFICATION	SPÉCIFICATION DE COMMANDE	CODE
MODEL MODÈLE	4238-19 OSLO	4238-19
LIGHT SOURCE SOURCE LUMINEUSE	LED	LED
<small>(WATTAGE, LAMP TYPE, OTHER INFO)</small>		
LED	REGULAR OUTPUT	
COLOR TEMPERATURE TEMPÉRATURE DE COULEUR		
27	2700K	
30	3000K	
35	3500K	
40*	4000K	
<small>* LONGER LEAD TIME MAY APPLY, PLEASE CONTACT YOUR EUREKA REPRESENTATIVE</small>		
COLOR RENDERING INDEX (CRI) INDICE DE RENDU DE COULEUR (IRC)	90	90
VOLTAGE VOLTAGE		
120V	120 VOLT	
277V	277 VOLT	
DIMMING OPTION OPTION DE GRADATION		
DV	0-10V DIMMING (120-277V)	
DP	PHASE DIMMING (120V ONLY)	
<small>LED DIMMING DRIVER IS STANDARD IN THIS PRODUCT. PLEASE SPECIFY YOUR DIMMING TYPE.</small>		
CABLE CABLE		AC
AC	AIRCRAFT MOUNTING & CLEAR CABLE, FIELD ADJUSTABLE	
CABLE LENGTH LONGUEUR DE CABLE		
60	60" AIRCRAFT CABLE (STD LENGTH)	
**	CUSTOM AIRCRAFT CABLE LENGTH (PLEASE SPECIFY)	
<small>FOR OVERALL LENGTH PLEASE CONTACT YOUR EUREKA REPRESENTATIVE.</small>		
CANOPY FINISH FINI PAVILLON		
WHE	WHITE FINE TEXTURE	
ANTE	ANTHRACITE FINE TEXTURE	
SHADE FINISH FINI ABAT-JOUR		
CHF	CHARCOAL FELT	
REF	RED FELT	
SGF	SILVER GRAY FELT	
NBF	NAVY BLUE FELT	
DECORATIVE PLATE FINISH FINI PLAQUE DÉCORATIVE		
WHE	WHITE FINE TEXTURE	
ANTE	ANTHRACITE FINE TEXTURE	

PRODUCT CHARACTERISTICS CARACTÉRISTIQUES DU PRODUIT



DESIGN:	Now available in two formats, this pendant features direct uplight and indirect downlight giving a nicely toned atmosphere to interior spaces. Made out of formed recycled acoustical PET felt, the shape reminds the effects of rippling water.
INSTALLATION:	Comes with triple aircraft cable configuration with level and height adjustment, for easier accessibility.
LIGHT SOURCE:	Designed with front as well as rear illumination, the Oslo features a LED light source with included 0-10V or phase dimming.
SHADE:	Using compression molding to create this beautiful volume, Oslo is available in 4 felt colours: red, blue, charcoal, silver gray. Made from recycled and recyclable polyester fibers (PET) with characteristics like low VOCs, no formaldehyde, non-irritable and odourless.
CERTIFIED:	c-CSA-us
CONCEPTION:	Maintenant offert en deux formats, ce luminaire chaleureux et délicat offre une illumination diffuse et d'ambiance. Fait de feutre acoustique en fibre de PET recyclé, sa forme rappelle l'ondulation de l'eau.
INSTALLATION:	Comportant trois câbles d'acier ajustables pour une mise à niveau et un ajustement plus facile.
SOURCE LUMINEUSE:	Offert avec une source DEL qui illumine dans deux directions, offert avec gradation de type 0-10V ou phase.
ABAT-JOUR:	Fabriqués par moulage en compression afin de créer son volume tout en courbes, Oslo est offert en 4 couleurs: rouge, bleu, gris pâle et charbon. Composé de fibres de polyéthylène (PET) recyclées et recyclables avec bas COV, sans formaldéhyde, non irritante et inodore.
CERTIFIÉ:	c-CSA-us

OSLO 4238-29

PROJECT PROJÉT
SPEC TYPE
NOTES



FAMILY FAMILLE

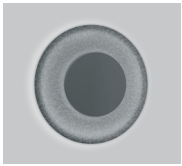

3038-29 (WALL)

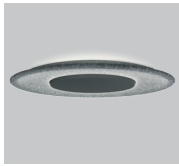

3038-19 (CEILING)

OPTIONS

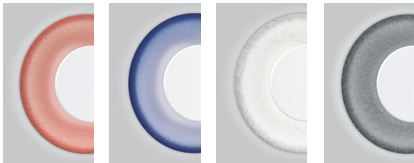

REF-WHE NBF-WHE SGF-WHE CHF-WHE

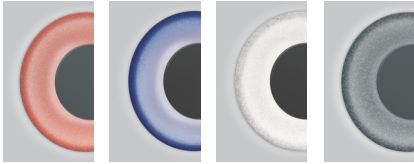

REF-ANTE NBF-ANTE SGF-ANTE CHF-ANTE

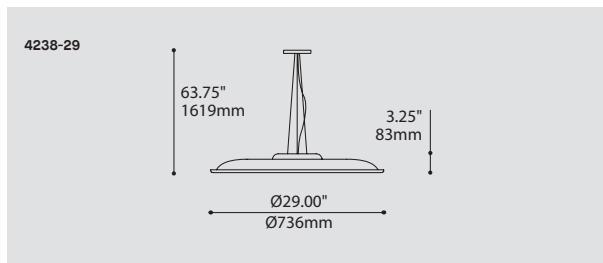

ORDERING SPECIFICATION	SPÉCIFICATION DE COMMANDE	CODE
MODEL MODÈLE		4238-29
4238-29	OSLO	
LIGHT SOURCE SOURCE LUMINEUSE		LED
(WATTAGE, LAMP TYPE, OTHER INFO)		
LED	REGULAR OUTPUT	
COLOR TEMPERATURE TEMPÉRATURE DE COULEUR		
27	2700K	
30	3000K	
35	3500K	
40*	4000K	
* LONGER LEAD TIME MAY APPLY, PLEASE CONTACT YOUR EUREKA REPRESENTATIVE		
COLOR RENDERING INDEX (CRI) INDICE DE RENDU DE COULEUR (IRC)		90
90	90+ CRI	
VOLTAGE VOLTAGE		
120V	120 VOLT	
277V	277 VOLT	
DIMMING OPTION OPTION DE GRADATION		
DV	0-10V DIMMING (120-277V)	
DP	PHASE DIMMING (120V ONLY)	
LED DIMMING DRIVER IS STANDARD IN THIS PRODUCT. PLEASE SPECIFY YOUR DIMMING TYPE.		
CABLE CABLE		AC
AC	AIRCRAFT MOUNTING & CLEAR CABLE, FIELD ADJUSTABLE	
CABLE LENGTH LONGUEUR DE CABLE		
60	60" AIRCRAFT CABLE (STD LENGTH)	
**	CUSTOM AIRCRAFT CABLE LENGTH (PLEASE SPECIFY)	
FOR OVERALL LENGTH PLEASE CONTACT YOUR EUREKA REPRESENTATIVE.		
CANOPY FINISH FINI PAVILLON		
WHE	WHITE FINE TEXTURE	
ANTE	ANTHRACITE FINE TEXTURE	
SHADE FINISH FINI ABAT-JOUR		
CHF	CHARCOAL FELT	
REF	RED FELT	
SGF	SILVER GRAY FELT	
NBF	NAVY BLUE FELT	
DECORATIVE PLATE FINISH FINI PLAQUE DÉCORATIVE		
WHE	WHITE FINE TEXTURE	
ANTE	ANTHRACITE FINE TEXTURE	

PRODUCT CHARACTERISTICS CARACTÉRISTIQUES DU PRODUIT



DESIGN:	Now available in two formats, this pendant features direct uplight and indirect downlight giving a nicely toned atmosphere to interior spaces. Made out of formed recycled acoustical PET felt, the shape reminds the effects of rippling water.
INSTALLATION:	Comes with triple aircraft cable configuration with level and height adjustment, for easier accessibility.
LIGHT SOURCE:	Designed with front as well as rear illumination, the Oslo features a LED light source with included 0-10V or phase dimming.
SHADE:	Using compression molding to create this beautiful volume, Oslo is available in 4 felt colours: red, blue, charcoal, silver gray. Made from recycled and recyclable polyester fibers (PET) with characteristics like low VOCs, no formaldehyde, non-irritable and odourless.
CERTIFIED:	c-CSA-us
CONCEPTION:	Maintenant offert en deux formats, ce luminaire chaleureux et délicat offre une illumination diffuse et d'ambiance. Fait de feutre acoustique en fibre de PET recyclé, sa forme rappelle l'ondulation de l'eau.
INSTALLATION:	Comportant trois câbles d'acier ajustables pour une mise à niveau et un ajustement plus facile.
SOURCE LUMINEUSE:	Offert avec une source DEL qui illumine dans deux directions, offert avec gradation de type 0-10V ou phase.
ABAT-JOUR:	Fabriqué par moulage en compression afin de créer son volume tout en courbes, Oslo est offert en 4 couleurs: rouge, bleu, gris pâle et charbon. Composé de fibres de polyéthylène (PET) recyclées et recyclables avec bas COV, sans formaldéhyde, non irritabile et inodore.
CERTIFIÉ:	c-CSA-us

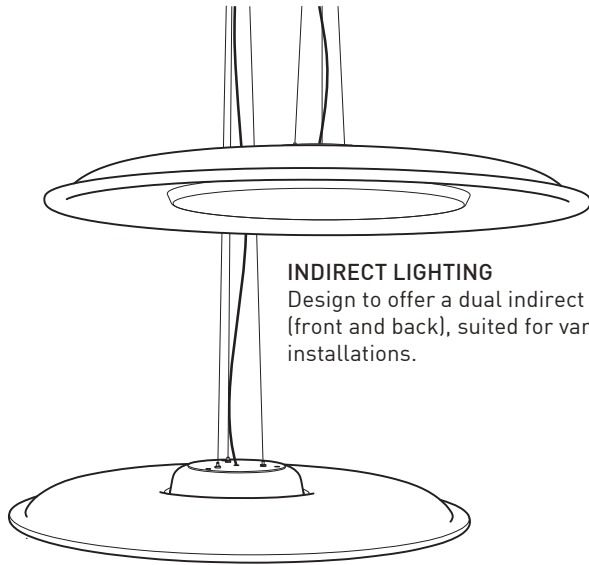

INDIRECT LIGHTING
Design to offer a dual indirect illumination (front and back), suited for various installations.

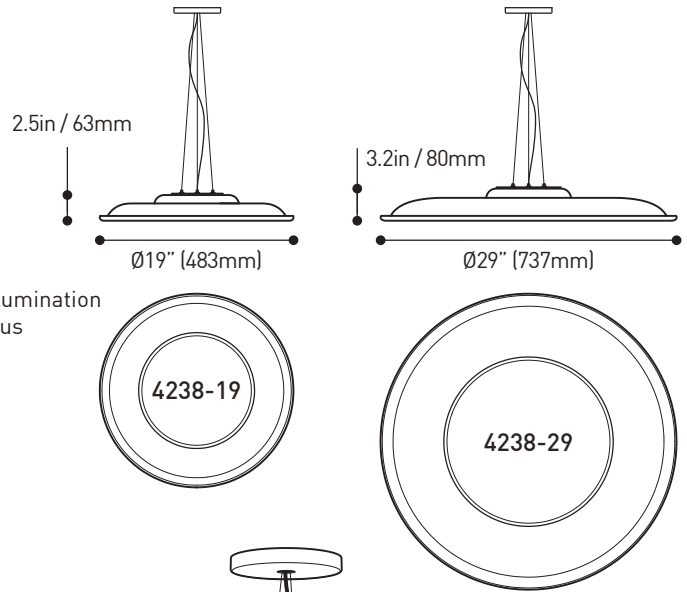

NOISE REDUCTION

Made with recycled PET, the Oslo custom molded reflector helps tone down noise in your space. Available in charcoal grey, silver grey, navy blue or red.

HIGH DIFFUSION

Custom made thermoformed and frosted white PMMA diffuser for a soft and even light.

HIGH PERFORMANCE LED MODULES
Custom made LED module.

FRONT PLATE
Die-spun steel dish, available in white or anthracite architectural grade fine textured finishes.

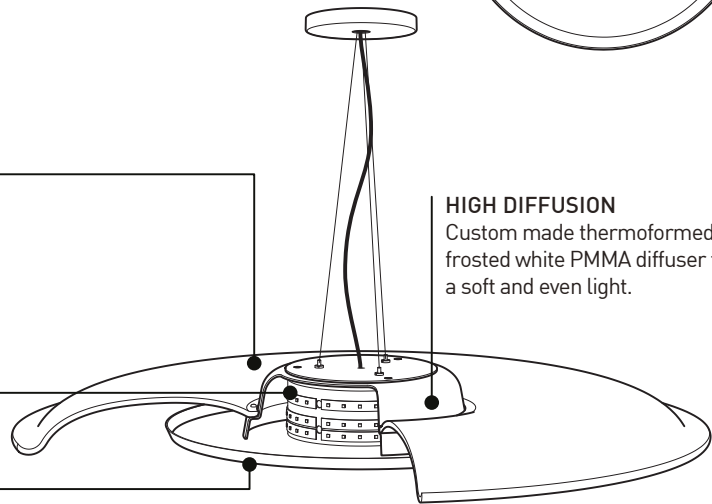

PRODUCT SPECIFICATION	4238-19	4238-29
PERFORMANCE	SGF / CHF	SGF / CHF
SYSTEM WATTAGE	23 W / 23 W	31 W / 31 W
DELIVERED LUMENS (4000K)	617 LM / 501 LM	1026 LM / 831 LM
EFFICACY	27 LM/W / 22 LM/W	33 LM/W / 26.8 LM/V
OTHER INFORMATION		
LUMINAIRE'S WEIGHT	1,8 KG / 4 LBS	4,1 KG / 9 LBS
L70 (LUMEN MAINTENANCE)	60 000 HRS	60 000 HRS
MAX. LUMINANCE 45°-90° OF NADIR	263 CD/M ²	215 CD/M ²
LIGHT QUALITY	R9 > 50	R9 > 50

EFFICACY MULTIPLIERS

CRI	CCT	FACTOR
90+	4000K	1.00
90+	3500K	0.96
90+	3000K	0.92
90+	2700K	0.87

LIGHT DISTRIBUTION

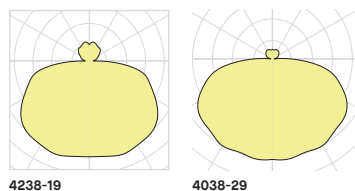

Visit our website for warranty terms and conditions.

3038-19 LED & 4238-19 LED	SGF	CHF
CCT (K):	4000	4000
Delivered Lumens (lm):	543	441
System wattage (W)*:	22,2	22,2
Distribution:	Direct	Direct
Delivered Efficacy (lm/W):	24	20
Photometric type	C	C

*System wattage include driver and LED module consumption

3038-29 LED & 4238-29 LED	SGF	CHF
CCT (K):	4000	4000
Delivered Lumens (lm):	903	731
System wattage (W)*:	31	31
Distribution:	Direct	Direct
Delivered Efficacy (lm/W):	29	23
Photometric type	C	C

*System wattage include driver and LED module consumption

